

Air conditioner

User manual

AR**DXFZ****

- Thank you for purchasing this Samsung air conditioner.
- Before operating this unit, please read this user manual carefully and retain it for future reference.



SAMSUNG

Contents

Safety Information	4
Safety Information	4
At a Glance	12
Indoor Unit Overview	12
Display	13
Remote Control Overview	14
Replacing the remote control batteries	14
Remote Control Operation	15
Selecting an operation mode	15
To set the temperature • To adjust the fan speed • To adjust the airflow direction	16
Smart Features	17
Power Smart Features	17
AI Auto mode • AI Energy mode	17
Auto mode • Cool mode	18
Dry mode • Fan mode	19
Variety Smart Features	20
Fast function	20
Eco function	21
Quiet function	22
Electricity consumption check • Beep function	23
Auto clean function	24
Display lighting function • Wi-Fi function (SmartThings app)	26
Time scheduling	27
Timed on/ Timed off function	27
good'sleep function	28

Cleaning and Maintenance	29
Schedule	29
Cleaning	30
Appendix	32
Troubleshooting	32
SmartThings app	34



***Correct Disposal of This Product
(Waste Electrical & Electronic Equipment)***

(Applicable in countries with separate collection systems)

This marking on the product, accessories or literature indicates that the product and its electronic accessories (e.g. charger, headset, USB cable) should not be disposed of with other household waste at the end of their working life. To prevent possible harm to the environment or human health from uncontrolled waste disposal, please separate these items from other types of waste and recycle them responsibly to promote the sustainable reuse of material resources.

Household users should contact either the retailer where they purchased this product, or their local government office, for details of where and how they can take these items for environmentally safe recycling.

Business users should contact their supplier and check the terms and conditions of the purchase contract. This product and its electronic accessories should not be mixed with other commercial wastes for disposal.



Correct disposal of batteries in this product

This marking on the battery, manual or packaging indicates that the batteries in this product should not be disposed of with other household waste at the end of their working life. Where marked, the chemical symbols Hg, Cd or Pb indicate that the battery contains mercury, cadmium or lead above the reference levels in EC Directive 2006/66.

Safety Information



WARNING: Read This Manual

Read and follow all safety information and instructions before installation, use, or maintenance of this appliance. Incorrect installation, use, or maintenance of this appliance can result in death, serious injury, or property damage. Keep these instructions with this appliance. This manual is subject to change. For the latest version, visit www.samsung.com.

Because the instructions in this manual cover various models, the characteristics of your air conditioner may differ slightly from those described. If you have any questions, please contact your service provider or visit www.samsung.com.

Notices and notes

To make you aware of safety messages and highlighted information, we use the following notices and notes throughout this manual:



WARNING

Hazards or unsafe practices that may result in severe personal injury or death.



CAUTION

Hazards or unsafe practices that may result in minor personal injury or property damage.



IMPORTANT

Information of special interest



NOTE

Supplementary information that may be useful



WARNING: Low burning velocity material (This appliance is filled with R-32.)



The user and installer guides should be read carefully.



The user and installer guides should be read carefully.



The service guide should be read carefully.

FOR GENERAL

This appliance is not intended for use by persons (including children) with reduced physical, sensory or mental capabilities, or lack of experience and knowledge, without supervision or instruction concerning use of the appliance by a person responsible for their safety. Children should be supervised to ensure that they do not play with the appliance.

Safety Information

FOR INSTALLATION



WARNING

Use a power cord with this product's power specifications or higher and use the power cord for this appliance only. In addition, do not use an extension cord.

- Extending the power cord may result in electric shock or fire.
- Do not use an electric transformer. This may result in electric shock or fire.
- If the voltage/frequency/rated current condition is different, it may cause fire.

The installation of this appliance must be performed by a qualified technician or service company.

- Failing to do so may result in electric shock, fire, explosion, problems with the product, or injury and may also void warranty on the installed product.

Install an Isolation Switch next to the Air Conditioner (but not on the panels of the Air Conditioner) and circuit breaker dedicated to the air conditioner.

- Failing to do so may result in electric shock or fire.

Fix the outdoor unit firmly so that the electric part of the outdoor unit is not exposed.

- Failing to do so may result in electric shock, fire, explosion, or problems with the product.

Do not install this appliance near a heater, or flammable material. Do not install this appliance in a humid, oily or dusty location, in a location exposed to direct sunlight and water (or rain). Do not install this appliance in a location where gas may leak.

- This may result in electric shock or fire.

Never install the outdoor unit in a location such as on a high external wall where it could fall.

- If the outdoor unit falls, it may result in injury, death or property damage.

This appliance must be properly grounded. Do not ground the appliance to a gas pipe, plastic, water pipe, or telephone line.

- Failing to do so may result in electric shock, fire, and explosion.
- Make sure to use a socket-outlet with ground.

 **CAUTION**

Install your appliance on a level and hard floor that can support its weight.

- Failing to do so may result in abnormal vibrations, noise, or problems with the product.

Install the drain hose properly so that water drains correctly.

- Failing to do so may result in water overflowing and property damage. Avoid adding drain to waste pipes as odours may arise in the future.

When installing the outdoor unit, make sure to connect the drain hose so that draining is performed correctly.

- The water generated during heating by the outdoor unit may overflow and result in property damage.
In particular, in winter, if a block of ice falls, it may result in injury, death or property damage.

Do not install the product in a place where thermo-hygrostat is needed (such as server room, machinery room, computer room, etc.)

- Those places do not provide guaranteed operation condition of the product therefore performance can be poor in these places.

FOR POWER SUPPLY

 **WARNING**

When the circuit breaker is damaged, contact your nearest service centre.

Do not pull or excessively bend the power line. Do not twist or tie the power line. Do not hook the power line over a metal object, place a heavy object on the power line, insert the power line between objects, or push the power line into the space behind the appliance.

- This may result in electric shock or fire.

If the supply cord is damaged, it must be replaced by the manufacturer, its service agent or similarly qualified persons in order to avoid a hazard.

 **CAUTION**

When not using the air conditioner for a long period of time or during a thunder/lightning storm, cut the power at the circuit breaker.

- Failing to do so may result in electric shock or fire.

Safety Information

FOR USING



WARNING

If the appliance is flooded, please contact your nearest service centre.

- Failing to do so may result in electric shock or fire.

If the appliance generates a strange noise, a burning smell or smoke, cut off the power supply immediately and contact the nearest service centre.

- Failing to do so may result in electric shock or fire.

In the event of a gas leak (such as propane gas, LP gas, etc.), ventilate immediately without touching the power line. Do not touch the appliance or power line.

- Do not use a ventilating fan.
- A spark may result in an explosion or fire.

To reinstall the air conditioner, please contact your nearest service centre.

- Failing to do so may result in problems with the product, water leakage, electric shock, or fire.
- Delivery service for the product is not provided. If you reinstall the product in another location, additional construction expenses and an installation fee will be charged.
- Especially, when you wish to install the product in an unusual location such as in an industrial area or near the seaside where it is exposed to salt in the air, please contact your nearest service centre.

Do not touch the circuit breaker with wet hands.

- This may result in electric shock.

Do not turn the air conditioner off with the circuit breaker while it is operating.

- Turning the air conditioner off and then on again with the circuit breaker may cause a spark and result in electric shock or fire.

After unpacking the air conditioner, keep all packaging materials well out of the reach of children, as packaging materials can be dangerous to children.

- If a child places a bag over its head, it may result in suffocation.

Do not touch the air-flow blade with your hands or fingers during heating.

- This may result in electric shock or burns.

Do not insert your fingers or foreign substances into the air inlet/outlet of the air conditioner.

- Take special care that children do not injure themselves by inserting their fingers into the product.

Do not strike or pull the air conditioner with excessive force.

- This may result in fire, injury, or problems with the product.

Do not place an object near the outdoor unit that allows children to climb onto the machine.

- This may result in children seriously injuring themselves.

Do not use this air conditioner for long periods of time in badly ventilated locations or near infirm people.

- Since this may be dangerous due to a lack of oxygen, open a window at least once an hour.

If any foreign substance such as water has entered the appliance, cut off the power supply and contact the nearest service centre.

- Failing to do so may result in electric shock or fire.

Do not attempt to repair, disassemble, or modify the appliance yourself.

- Do not use any fuse (such as copper, steel wire, etc.) other than the standard fuse.
- Failing to do so may result in electric shock, fire, problems with the product, or injury.



CAUTION

Do not place objects or devices under the indoor unit.

- Water dripping from the indoor unit may result in fire or property damage.

Check that the installation frame of the outdoor unit is not broken at least once a year.

- Failing to do so may result in injury, death or property damage.

To prevent personal injury, make sure that you change the directions of the horizontal air flow blades after stopping the movements of the vertical air flow blade. (In case of adjusting the horizontal air-flow manually)

Do not install the product in a ship or a vehicle (such as a campervan).

- Salt, vibration or other environmental factor may cause the product malfunction, electric shock or fire.

Do not stand on top of the appliance or place objects (such as laundry, lighted candles, lighted cigarettes, dishes, chemicals, metal objects, etc.) on the appliance.

- This may result in electric shock, fire, problems with the product, or injury.

Do not operate the appliance with wet hands.

- This may result in electric shock.

Do not spray volatile material such as insecticide onto the surface of the appliance.

- As well as being harmful to humans, it may also result in electric shock, fire or problems with the product.

Do not drink the water from the air conditioner.

- The water may be harmful to humans.

Do not hit, shake, drop, or attempt to disassemble the remote control.

When replacing the remote control batteries, keep them out of the reach of infants.

- If an infant eats batteries, contact a doctor immediately.

When replacing the remote control batteries, be careful not to get the battery fluid on your skin.

- Battery fluid is harmful to humans.

Do not touch the pipes connected with the product.

- This may result in burns or injury.

Safety Information

Do not use this air conditioner to preserve precision equipment, food, animals, plants or cosmetics, or for any other unusual purposes.

- This may result in property damage.

Avoid directly exposing humans, animals or plants to the air flow from the air conditioner for long periods of time.

- This may result in harm to humans, animals or plants.

FOR CLEANING



WARNING

Do not clean the appliance by spraying water directly onto it. Do not use benzene, thinner or alcohol to clean the appliance.

- This may result in discolouration, deformation, damage, electric shock or fire.

Before cleaning or performing maintenance, cut off the power supply and wait until the fan stops.

- Failing to do so may result in electric shock or fire.



CAUTION

Take care when cleaning the surface of the heat exchanger of the outdoor unit since it has sharp edges.

- This should be done by a qualified technician. Please contact your installer or service centre.

Do not clean the inside of the air conditioner by yourself.

- For cleaning inside the appliance, contact your nearest service centre.
- When cleaning the filter, refer to the descriptions in the 'Cleaning' section of the Quick Guide.
- Failing to do so may result in damage, electric shock or fire.
- Make sure to prevent any injury from sharp edges of the surface when handling the heat exchanger.

FOR R-32 REFRIGERANT



WARNING

In case of a malfunction, immediately stop operation of the air conditioner and disconnect the entire power system. Then consult the authorized service personnel.

Do not use means to accelerate the defrost operation or to clean, other than those recommended by Samsung.

Do not pierce or burn.

Be aware that refrigerants may not contain an odour.



CAUTION

The product shall be stored in a room with no ignition sources (e.g. open flames, gas appliance, electric heater, etc.).

- Note that the refrigerant has no odour.

When the air conditioner does not operate properly for cooling or heating, there is a possibility of refrigerant leakage. If any leakage, stop operation, ventilate the room, and consult your dealer immediately for recharging refrigerant.

The refrigerant is not harmful. However, if it comes in contact with fire, it may generate harmful gases and there is risk of fire.

During transportation of the indoor unit, the pipe lines shall be covered with brackets for protection. Do not move the product with holding the pipe lines.

- It may cause gas leakage.

Do not cut or burn the refrigerant container or pipings.

Do not point the air direction to the fireplace or heater.

Indoor Unit Overview

The appearance of the actual product may differ slightly from the image below.

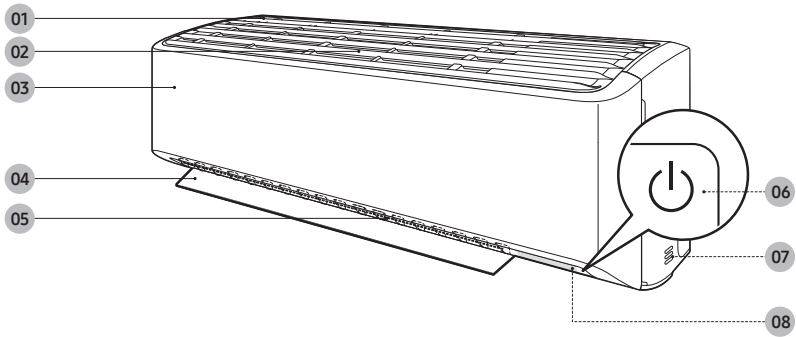

- 01 Air intake
- 02 Air filter
- 03 Front panel
- 04 Airflow blade (up and down)
- 05 Airflow blade (left and right)
- 06 Power button/Remote control receiver
- 07 Room temperature sensor
- 08 Display

Display

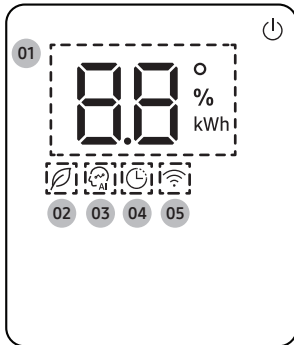

- 01 Temperature indicator (numeric)
Filter reset indicator (⏏ F)
Electricity consumption indicator (numeric)
Auto clean indicator (⏏ ⚡)
- 02 AI Energy indicator
- 03 AI Auto indicator
- 04 Timer indicator
good'sleep indicator
- 05 Wi-Fi indicator

NOTE

- When the Wi-Fi is turned on, the indicator blinks three times and then turn on.

NOTE

- If the Wi-Fi indicator blinks for 10 seconds when operation starts, it means that the air conditioner is not connected to Wi-Fi. See "SmartThings app" on page 34 and connect the air conditioner to Wi-Fi.
- When connected to Wi-Fi, the air conditioner can gather and learn your user patterns so that it can run in AI Auto mode.

Remote Control Overview

Most operating instructions in this manual require using the remote control.

At a Glance

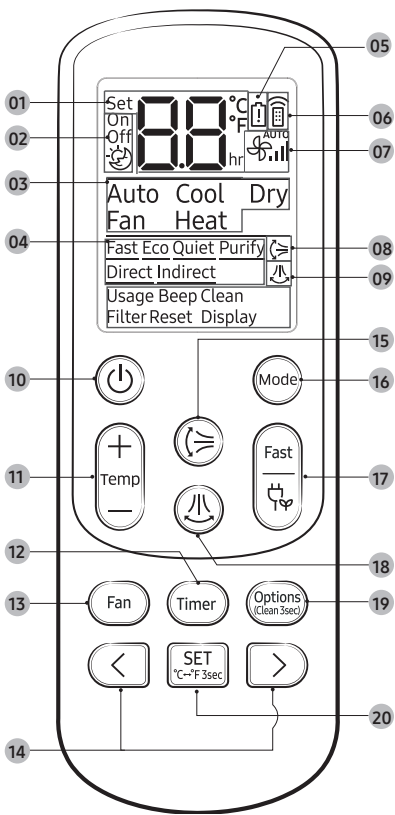

- 01 Set temperature indicator
- 02 Timer option indicator
- 03 Operation mode indicator
- 04 Options indicator
- 05 Low battery indicator
- 06 Transmit indicator
- 07 Fan speed indicator
- 08 Vertical air swing indicator
- 09 Horizontal air swing indicator
- 10 Power button
- 11 Temperature button
- 12 Timer button
- 13 Fan speed button
- 14 Direction button/Selection button
- 15 Vertical air swing button
- 16 Mode button
- 17 Fast/Eco button
- 18 Horizontal air swing button
- 19 Options/Clean button
- 20 SET button/Temperature type button(°C↔°F)

NOTE

- Although Purify, Usage, Direct is displayed on the remote control display, it is not available on this model.

Replacing the remote control batteries

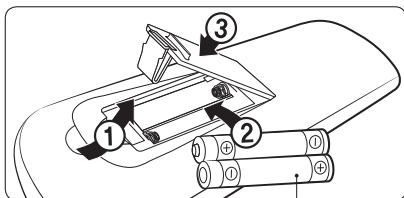

Two 1.5V AAA batteries

Remote Control Operation

You can use the air conditioner easily by selecting a mode and then by controlling the temperature, fan speed, and air direction.

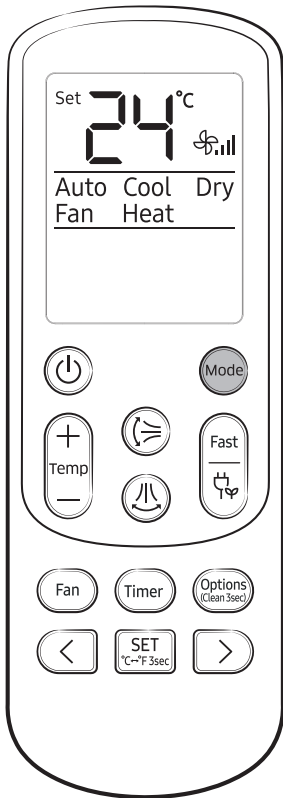

Selecting an operation mode

To change the current mode between Auto, Cool, Dry, and Fan press the  (Mode) button.

You can use AI Auto mode after Wi-Fi is connected.

NOTE

You can use the Cool, and Dry modes in the following operation range.

Mode	Cool	Dry
Indoor temperature	16 °C to 32 °C	18 °C to 32 °C
Outdoor temperature	16 °C to 46 °C	16 °C to 46 °C
Indoor humidity	Relative humidity of 80 % or less ¹⁾	-

¹⁾If the air conditioner operates in Cool mode in a high-humidity environment for an extended period of time, condensation may occur.

You can switch between Celsius and Fahrenheit indications on the remote control.



▶ Press and hold for 3 or more seconds.

NOTE

- The temperature indications on the indoor unit are not switched.
- This function is canceled when the remote control batteries are replaced. In this case, run this function again.

Remote Control Operation









To set the temperature

To control the temperature in each mode, press the  (Temperature) button:

Mode	Temperature control
AI Auto/Auto/Cool	Adjust by 1 °C from 16 °C to 30 °C.
Dry	Adjust by 1 °C from 18 °C to 30 °C.
Fan	No temperature control.

To adjust the fan speed

Select from the following fan speeds in each mode:

Mode	Available fan speeds
AI Auto/Auto/Dry	 (Auto)
Cool/Fan	 (Auto),  (Low),  (Med),  (High),  (Turbo)

To adjust the airflow direction

Keep the airflow in a constant direction by stopping the movements of the vertical and horizontal airflow blades.

In operation ►  or 

NOTE

- If you adjust the vertical airflow blade manually, it may not close completely when you turn off the air conditioner.
- Always use the remote control to adjust the airflow blades. Do not move the blades by hand. They may not operate normally.
- You cannot control the horizontal airflow direction in Cool mode when the good'sleep function is on.

Power Smart Features

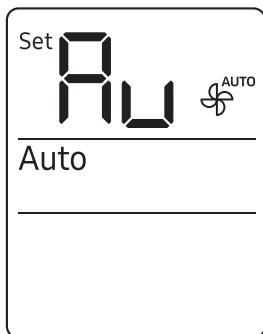



AI Auto mode

Use AI Auto mode to automatically operate any of Cool and Dry modes depending on the learned user patterns gathered from an external server via Wi-Fi module. The favourite temperature and operation mode are also set based on the current temperatures (indoor/outdoor) and the gathered user patterns.

 ►  ► Select Auto.

NOTE

- You can use this mode after Wi-Fi is connected. Otherwise, Auto mode is activated.
- In AI Auto mode, the  (AI Auto) and  (Wi-Fi) indicators appear on the display of the indoor unit.
- If the gathered user patterns are not sufficient, the set temperature is set based on the user's activity time and indoor/outdoor temperatures.
- The set temperature is controlled within the range of 22 °C to 28 °C in AI Auto mode. You can also change it manually.
- An automatically changed set temperature is shown on the display of the indoor unit.
- When you press  (Mode) in AI Auto mode, the mode is cancelled.
- If you change the set temperature in AI Auto mode, it automatically changes back to the AI comfort temperature after 1 hour.

AI Energy mode

- Use AI Energy mode to save electricity consumed by the operating air conditioner. This mode can be turned on or off from the SmartThings app only.
- The amount of saved electricity is calculated while in AI Auto mode only.
- AI Energy indicator () lights up on the display of the indoor unit.
- The amount of saved electricity is calculated from the moment when the air conditioner is turned on.
- The amount of saved electricity may differ even when using the same device, depending on the ambient environment (e.g., indoor/outdoor temperature and humidity), set temperature, and operation mode.
- Note that the amount of saved electricity also may differ even under the same operating environment conditions, depending on how it was measured.
- To have powerful cooling, turn off AI Energy mode in the SmartThings app.

Power Smart Features

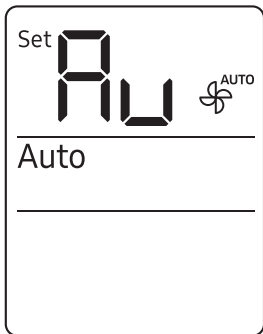

Auto mode

Use Auto mode to perform the powerful cooling function to automatically reach the desired temperature. When the difference between the room temperature and the set temperature decreases, the air conditioner controls the fan speed and airflow direction.



NOTE

- If Wi-Fi cannot be connected or the Wi-Fi function is not supported, this Auto mode is automatically activated instead of AI Auto mode.
- When the room temperature is higher than the set temperature, the air conditioner automatically produces cool air.

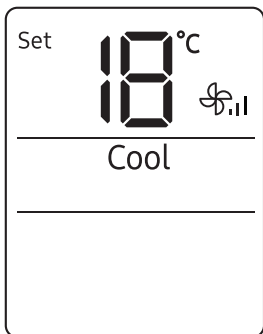

Cool mode

Use Cool mode to stay cool in hot weather.



NOTE

- For comfort, keep the temperature difference between the indoor and outdoor air within 5 °C.
- After selecting Cool mode, select the desired function, temperature, and fan speed.
 - To cool more quickly, select a lower temperature and a faster fan speed.
 - To save energy, select a higher temperature and a slower fan speed.
 - As the room temperature nears the set temperature, the compressor motor will slow down to save energy.

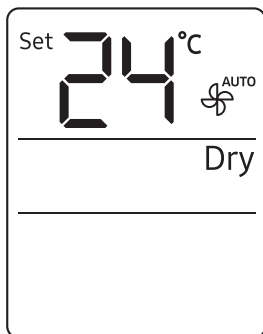

Dry mode

Use Dry mode in rainy or humid weather.



NOTE

- The proper set temperature range for dehumidifying operation is 24 to 26 °C. If you feel that the current humidity seems high, use a lower set temperature.

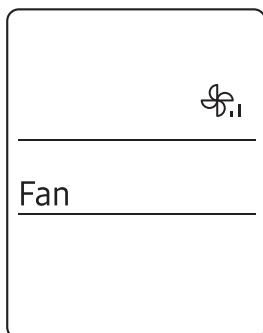

Fan mode

Use Fan mode to run the air conditioner like a floor fan, providing a breeze without cooling.



NOTE

- If the air conditioner will not be used for an extended period of time, run it in Fan mode for 3 to 4 hours to dry the internal components.
- The outdoor unit does not operate in Fan mode. This is normal and not a fault with the air conditioner.

Variety Smart Features

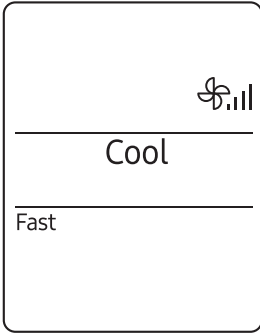

Fast function

Use the Fast function to quickly cool your room. This function is the most powerful cooling function provided by the air conditioner. You can select this function in Cool mode.

In Cool mode ▶ 

NOTE

- You can change the airflow direction, but you cannot change the set temperature and the fan speed.
- Selecting the Fast function cancels the Eco, good'sleep, and Quiet functions.
- You can also start the Fast function from the Options menu:

In Cool mode ▶  ▶   ▶

Select Fast. ▶ 

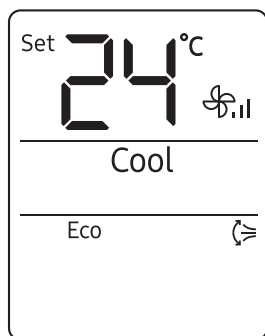

Eco function

Use the Eco function to reduce electricity consumption while staying cool. You can select this function in Cool mode.

In Cool mode ▶ ▶ ▶

Select Eco. ▶

NOTE

- When the Eco function starts, the pattern appears on the remote control for a few seconds and vertical air swing begins.
- You can change the set temperature, airflow direction, and fan speed.
- The allowed set temperatures while the Eco function is on are:

Mode	Minimum set temperature	Maximum set temperature
Cool	24 °C	30 °C

- If you change the set temperature to be outside the allowed range for the current mode, the set temperature is automatically reset to be within the range.
- When you turn off the Eco function, the air swing continues. Use the (Vertical air swing) or (Horizontal air swing) button to turn it off.
- Selecting the Eco function cancels the good'sleep, Fast, and Quiet functions.

Variety Smart Features

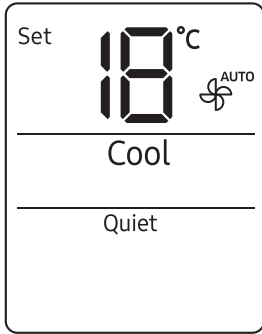

Quiet function

Use the Quiet function to reduce the unit's operating noise. You can select this function in Cool mode.

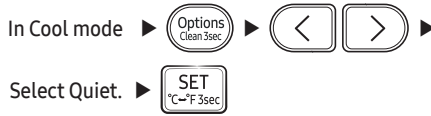

NOTE

- You can change the set temperature and the airflow direction, but you cannot change the fan speed.
- Selecting the Quiet function cancels the Eco, good'sleep, and Fast functions.

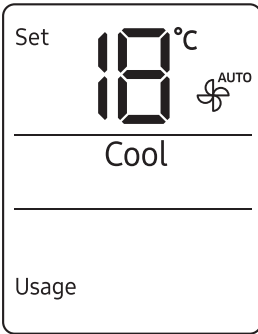

Electricity consumption check

Use the Usage function to check the amount of electricity consumed by using the air conditioner. The amount consumed is displayed on the indoor unit display for a few seconds, and the set temperature appears.

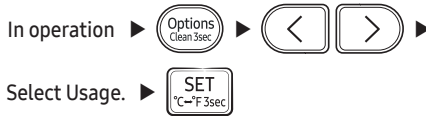

The value range displayed is between 0.1 kWh and 99 kWh. Electricity consumption is calculated from the moment the air conditioner turns on. The value is reset when the air conditioner turns off.

NOTE

- The usage shown on the indoor unit display may slightly differ from the amount of electricity actually consumed.
- You can view electricity consumption only when the air conditioner is operating.

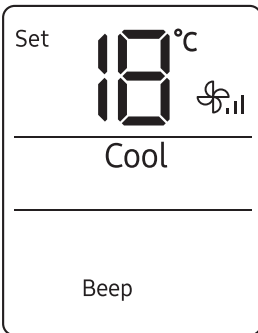

Beep function

Use the Beep function to turn on or off the beep that sounds when you press a button on the remote control.



Variety Smart Features

Auto clean function

Use the Auto clean function if the indoor unit produces odors.

Activating Auto clean

To activate Auto clean, press the  (Options) button for at least 3 seconds.

The indoor unit display shows:

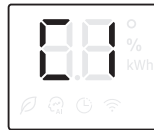

If the air conditioner is off, Auto clean starts immediately. If the air conditioner is running, Auto clean starts as soon as the air conditioner turns off.

NOTE

- You can also activate Auto clean from the Options menu:



- Once Auto clean is selected, it is always activated whenever the air conditioner turns off.
- Auto clean runs for 10 to up to 30 minutes depending on internal dry conditions. The indoor unit display shows the cleaning progress from 1% to 99%.
- If you start another function while Auto clean is progressing, Auto clean pauses and will resume when the other function stops.
- When Auto clean completes, the air conditioner turns off.
- Auto clean does not run after Fan mode.

Canceling Auto clean

To cancel Auto clean while it is running, follow the procedure below:

 ► Press and hold for 3 or more seconds.

OR

 ►   ► Select Clean. ► 

NOTE

- Canceling Auto clean does not deactivate it.

Deactivating Auto clean

To deactivate Auto clean, follow the procedure below while the air conditioner is in operation :

 ► Press and hold for 3 or more seconds.

OR

 ►   ► Select Clean. ► 

Variety Smart Features

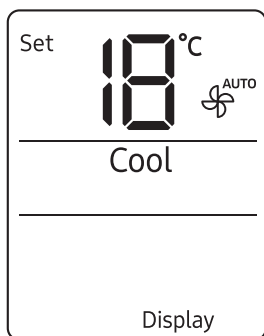

Display lighting function

Use the Display lighting function to turn on or off the lighting of the indoor unit display.



NOTE



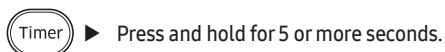

- If you change the current mode or function when the Display lighting function is on, the display lighting turns on for 5 seconds and then turns off again.
- To turn off the Display lighting function, run the method above again or turn the product off and on.

Wi-Fi function (SmartThings app)

Turn on the Wi-Fi function to pair your smartphone with the air conditioner.



NOTE

- When you turn on the Wi-Fi function, your smartphone pairs with the air conditioner, the  (Transmit) indicator blinks, and **AP** appears on the remote control display for a few seconds.
- Once your smartphone is connected with the air conditioner, you can control it via the wireless Internet using the SmartThings app installed on your smartphone.
- For more information about how to prepare your smartphone for connection and how to control the air conditioner using the SmartThings app, see "SmartThings app" on page 34.
- To turn on or off the Wi-Fi, press and hold  (Mode) and  for 5 seconds.
 - In order to launch the SmartThings app, press and hold the  (Timer) button for 5 seconds, which enables to connect the air conditioner.

Time scheduling

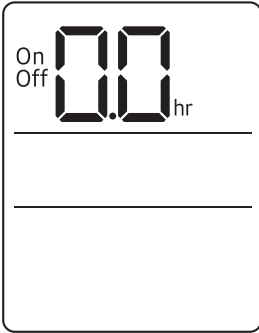

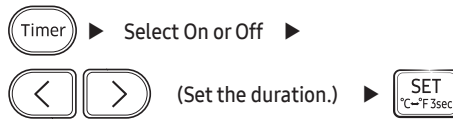

Timed on/ Timed off function

Use the Timed on/off function to turn the air conditioner on or off after a duration. Scheduling durations before the air conditioner turns on or off helps use the air conditioner economically.



NOTE

- To cancel the Timed on/off function, set the duration to 0.0.
- When you start the Timed on/off function, the  (Timer) indicator appears on the indoor unit display.
- You can set the duration to from 0.5 hours to 12 hours.
- You cannot set the same duration for both Timed on and Timed off functions.

Combining Timed on and Timed off	
When the air conditioner is off	Example: Timed on 3 hours, Timed off 5 hours The air conditioner turns on 3 hours after the last time you press the  (SET) button to start the Timed on/off function, remains on for 2 hours, then turns off again.
When the air conditioner is on	Example: Timed on 3 hours, Timed off 1 hour The air conditioner turns off 1 hour after the last time you press the  (SET) button to start the Timed on/off function, remains off for 2 hours, then turns on again.

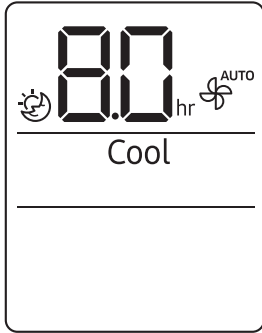

Time scheduling



good'sleep function

Use the good'sleep function to save energy while you are sleeping. You can select this function in Cool mode.

In Cool mode ▶ **Timer** (Select ) ▶

  (Set the duration.) ▶ 

NOTE

- To cancel the good'sleep function, set the duration to 0.0.
- When you start the good'sleep function, the  (Timer) indicator appears on the indoor unit display.
- You can set the duration to from 0.5 hours to 24 hours.
- The recommended set temperatures while the good'sleep function is on are:

Mode	Recommended set temperature	Optimal set temperature
Cool	25 °C to 27 °C	26 °C

- Selecting the good'sleep function cancels Eco, Fast, and Quiet functions.

Schedule

Task	How often	By whom	Instruction
Run the Auto clean function.	As needed	Owner	"Auto clean function" on page 24.
Clean the filter.	Once every two weeks	Owner	"Cleaning the filter" on page 31.
Clean the exterior of the indoor unit.	As needed	Owner	"Cleaning the outside of the indoor unit" on page 30.
Clean the exterior of the outdoor unit.	At least once a year	Owner	"Cleaning the heat exchanger on the outdoor unit" on page 30.
Replace the remote control batteries	As needed	Owner	"Replacing the remote control batteries" on page 14.
Apply corrosion inhibitor on outdoor unit. (Only if installed near salt water such as an ocean)	At least once a year	Qualified technician	Contact your service provider.
Clean inside the indoor or outdoor unit.	Once a year	Qualified technician	Contact your service provider.
Inspect the units, electrical connections, refrigerant tubes, and protections.	Once a year	Qualified technician	Contact your service provider.

Cleaning

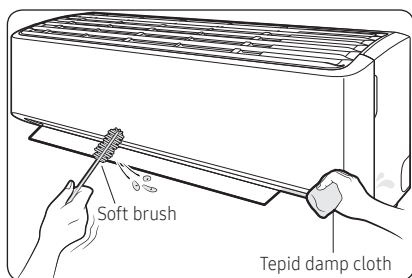

Cleaning the outside of the indoor unit

- 1 Turn off the air conditioner and wait until the fan stops.
- 2 Disconnect the power supply.
- 3 Use a soft brush or tepid damp cloth to clean the exterior.

WARNING

- Do not clean the appliance by spraying water directly onto it. Water entering the unit may result in electric shock or fire that could cause death, serious injury, or property damage:

CAUTION

- Do not use an alkaline detergent to clean the indoor unit display.
- Do not use sulphuric acid, hydrochloric acid, or organic solvents such as paint thinner, kerosene, acetone, benzene, or alcohol to clean the unit surfaces.

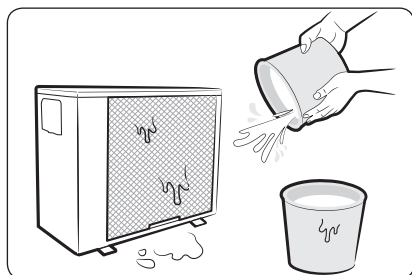

Cleaning the heat exchanger on the outdoor unit

- 1 Turn off the air conditioner and wait until the fan stops.
- 2 Disconnect the power supply.
- 3 Spray water on the heat exchanger to remove dust and other debris.

CAUTION

- Do not use sulphuric acid, hydrochloric acid, or organic solvents such as paint thinner, kerosene, acetone, benzene, or alcohol to clean the unit surfaces.
- If you need to inspect or clean the inside of the heat exchanger on the outdoor unit, contact a local service centre for help.

Cleaning the filter

Clean the air filter every two weeks or when the **CF** (filter-cleaning reminder) appears on the indoor unit display. The time between cleanings may vary, depending on the usage and environmental conditions.

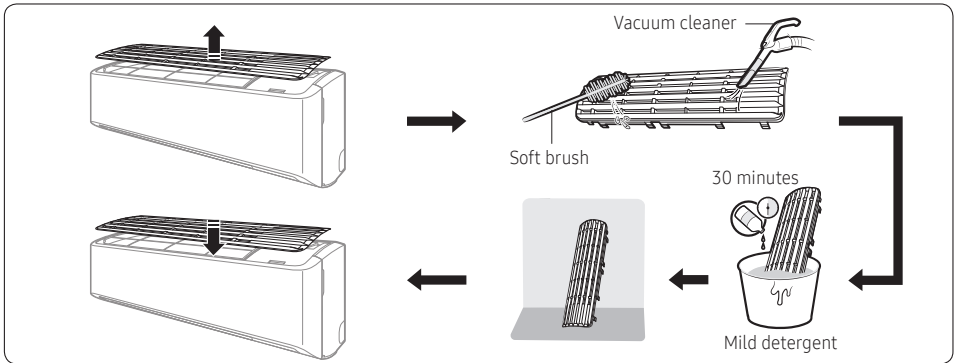

- 1 Slide the filter off of the unit.
- 2 Use a soft brush or vacuum cleaner to remove any dust or debris on the filter.
- 3 Soak the filter in a solution of water and mild detergent for 30 minutes.
- 4 Rinse the filter and let it air dry in a well-ventilated area that is out of direct sunlight.
- 5 Reinstall the filter.
- 6 Reset the filter-cleaning reminder:





⚠ CAUTION

- Take care not to damage the filter during cleaning.
- Do not scrub the air filter with a hard-bristle brush or another cleaning utensil.
- Do not expose the air filter to direct sunlight when drying it.

Troubleshooting

If the air conditioner is not operating normally, refer to the troubleshooting guide below.

Problem	Solution
<p>The air conditioner stops working.</p>	<ul style="list-style-type: none"> • Make sure the unit is receiving power. • Check the circuit breaker. If it is flipped off, flip it on again and restart the unit. If the problem persists, contact your service provider. • The Timed off function may have turned off the unit. Turn on the unit again.
<p>Cannot change the temperature.</p>	<ul style="list-style-type: none"> • Check if the unit is in Fan or Fast mode. If so, you cannot change the set temperature; the unit automatically controls the set temperature.
<p>Improper airflow temperature.</p>	<ul style="list-style-type: none"> • Check the set temperature. In Cool mode, cooling occurs only when the set temperature is lower than the current temperature. • Use the  (Temperature) button on the remote control to change the set temperature. • Check if the air filter is blocked with dirt or debris. If the air filter is blocked, the cooling performance may decrease. Clean the air filter regularly (page 31). • Check if the outdoor unit is covered or is installed near obstacles. Remove the coverings and obstacles. • Check if doors or windows are open. This may cause poor circulation or performance. Close all doors and windows. • Check if the pipe length between the units exceeds the maximum pipe length (see "Typical installation" in the Installation manual). If so, the cooling performance may decrease.
<p>Cannot change the airflow direction.</p>	<ul style="list-style-type: none"> • Check if the good'sleep function is on in Cool mode. If so, you cannot control the airflow direction.
<p>Cannot change the fan speed.</p>	<ul style="list-style-type: none"> • Check if the unit is in Auto, Dry, or Fast mode or the good'sleep function is on in Cool mode. In these conditions, you cannot control the fan speed; the unit automatically controls the fan speed.

Problem	Solution
The remote control does not work.	<ul style="list-style-type: none"> • Replace the batteries in the remote control. • Make sure the remote control can send an unobstructed signal to the unit. • Keep bright lights away from the unit. Light from fluorescent bulbs or neon signs may interrupt the signal from the remote control.
The Timed on/off function does not work.	<ul style="list-style-type: none"> • Make sure to press the  (SET) button on the remote control when setting the timer.
The indicator on the indoor unit blinks continuously.	<ul style="list-style-type: none"> • Press the  (Power) button to turn off the unit, or disconnect the power plug. • If the indicator light on the indoor unit continues blinking, contact your service provider.
Odors are coming from the unit during regular operation.	<ul style="list-style-type: none"> • If the unit is operating in a smoky area, ventilate the room or operate the unit in Fan mode for 3 to 4 hours. There are no components in the unit that produce a strong odor. • Check if the drain lines are clean. Clean them regularly.
The indoor unit display shows an error message.	<ul style="list-style-type: none"> • If the indoor unit indicator blinks, write down the error code. Contact your service provider and provide them with the error code.
The unit is generating noise.	<ul style="list-style-type: none"> • It is normal for the unit to generate some noise while operating. If the pipe length between the units is less than 3 m and no coil was used (see "Typical installation" in the Installation manual), additional noise may be transmitted from the outdoor unit to the indoor unit via the piping.
Water drips from the pipe connections on the outdoor unit.	<ul style="list-style-type: none"> • Condensation may develop when the ambient temperature or humidity changes significantly. This is normal.
Condensation forms on the surface of the indoor unit.	<ul style="list-style-type: none"> • If the humidity is higher in the room in Cool mode, or the difference between the desired temperature and indoor temperature is great, condensation may form on the surface of the indoor unit.

SmartThings app

Use the SmartThings app on your smartphone to control the air conditioner via the wireless Internet. To remotely control the air conditioner, you need to connect your smartphone to the air conditioner. If already connected, skip to "Step 6. Controlling the air conditioner with your smartphone" on page 35.

Step 1. Checking the requirements for connection

Before connecting your smartphone with the air conditioner, make sure that the following requirements are met:

- Wi-Fi access point: 2.4 GHz Wi-Fi access point only
- The air conditioner and your smartphone must be within the coverage of the same Wi-Fi access point and connected to it. After the connection, you can control the air conditioner from any place via various wireless networks such as Wi-Fi, 3G, LTE and 5G.
- The SmartThings app supports Android OS 7.0 or later (with at least 2 GB RAM) and iOS 12.0 or later. The app is optimized for iPhone 6s or later and Samsung smartphones (Galaxy S and Note series). The updates of the SmartThings app or the functions supported by it may be discontinued for the previously supported OS versions due to the reasons such as usability and security.

Step 2. Connecting your smartphone to the Wi-Fi network

- 1 Turn on the Wi-Fi access point.
- 2 Tap **Settings** → **Wi-Fi** on your smartphone.
- 3 Tap the **Wi-Fi** switch to activate it, and then select the 2.4 GHz Wi-Fi access point to connect to.
- 4 If needed, enter the password for the access point.
- 5 Tap **Advanced**.
- 6 Tap the **Switch to mobile data** switch to deactivate it.

Step 3. Installing the SmartThings app

If the SmartThings app is not installed on your smartphone, follow the procedure below. If installed, skip to "Step 4. Configuring the SmartThings app" on page 34.

- 1 Launch **Play Store** or **App Store**.
- 2 Tap the search field, and then search for "SmartThings".
- 3 Tap **INSTALL** for the found SmartThings app item.
- 4 Select **Agree**.





Step 4. Configuring the SmartThings app

After the SmartThings app is installed, follow the procedure below to configure it. If already configured, skip to "Step 5. Connecting your smartphone to the air conditioner" on page 35.

- 1 Launch the **SmartThings** app.
- 2 When you see pop-up windows asking for location, Wi-Fi, Bluetooth permissions, tap **Start**.
- 3 Tap **Log In**.
- 4 If you have no Samsung account, tap **Add account** to create your Samsung account.
- 5 Log in to your Samsung account.
- 6 Consent to **TERMS AND CONDITIONS**.
- 7 When you see a pop-up window asking for access permission to location information, tap **ALLOW**.

Step 5. Connecting your smartphone to the air conditioner

- 1 Plug in the power cord of the air conditioner, and then turn on the power.
- 2 Launch the **SmartThings** app.
- 3 Tap **Add device** on the home screen of the SmartThings app.
- 4 Tap **ADD DEVICE MANUALLY**.
- 5 Tap **Air conditioner** > **Room air conditioner**.
- 6 Press the  (Timer) button on the remote control for at least 4 seconds.

To notify that registration of the selected air conditioner to your Samsung account is in progress, the  (Transmit) indicator blinks for several seconds and  appears on the remote control display. When the connection is finished, the  (Transmit) indicator turns off and  disappears. A new device card for the selected air conditioner is added to the home screen of the SmartThings app.

Step 6. Controlling the air conditioner with your smartphone

- 1 Launch the **SmartThings** app.
- 2 On the home screen of the SmartThings app, tap the device card for the air conditioner, which was added when you proceeded with "Step 5. Connecting your smartphone to the air conditioner" on page 35.

WARNING

- RF exposure warning statement – for keeping 20cm distance when installing this module.
- Warning that this module should not be installed and operating simultaneously with other radio without additional evaluation or FCC filing.

- Your device uses non-harmonised frequency and is intended for use in all European countries. The WLAN can be operated in the EU without restriction indoors, but cannot be operated outdoors in France.

Specifications

Wi-Fi	
Frequency Range	Transmitter Power(Max)
2412 - 2472 MHz	20 dBm

Open Source Announcement

The software included in this product contains open source software. You may obtain the complete corresponding source code for a period of three years after the last shipment of this product by sending an email to <mailto:oss.request@samsung.com>.

It is also possible to obtain the complete corresponding source code in a physical medium such as a CD-ROM; a minimal charge will be required.

The following URL http://opensource.samsung.com/opensource/SMART_AT_051/seq/0 leads to the download page of the source code made available and open source license information as related to this product. This offer is valid to anyone in receipt of this information.



QUESTIONS OR COMMENTS?

COUNTRY	CALL	OR VISIT US ONLINE AT
AUSTRALIA	1300 362 603 (Other)	www.samsung.com/au/support